Cable Cleats for Short Circuit Protection

A complete guide to testing,
design and selection





This white paper explains what a short circuit event is, the impact short circuits can have on your facility and how to mitigate their effects through the use of cable cleats.



SECTION 1: SHORT CIRCUIT FAULTS – PROTECTING WITH CABLE CLEATS	4-9
Definition of a Short Circuit Fault.....	4
Common Causes of Short Circuit Faults	5
Definition of a Cable Cleat.....	6
Timing of a Short Circuit Fault	7-8
The Necessity of Cable Cleats	9
SECTION 2: CABLE CLEAT DEVELOPMENT PROCESS	10-16
IEC 61914:2015 Cable Cleats for Electrical Installations	10
IEC 61914:2015 Cleat Testing Criteria.....	11
IEC 61914:2015 Short Circuit Force Calculations	12
1. Selecting Cable Cleats	13
2. Cable Cleat Calculation Example	13
3. The Panduit Cleat kAlculator™ App	14
Panduit Cleat Development Process	15-16
SECTION 3: CABLE CLEAT STANDARDS AND TECHNICAL FOREFRONT	17-31
IEC 61914:2015 – Testing Methodology	17
1. Temperature Rating.....	18
2. Lateral Load Testing.....	19
3. Axial Load Testing	20
4. Impact Resistance	21-22
5. Corrosion Resistance	22
6. Salt Spray Test.....	22
7. UV Resistance.....	23
8. Resistance to Electromechanical	23-24
Multi Physics Simulation vs. IEC Short Circuit Force Calculations.....	25
1. Assumptions in IEC 61914:2015	26
2. Force During a Short Circuit Event.....	26
3. High Strain Rate	27
4. Dynamic Behavior of Cable	28
5. Validation of Multi-Physics Simulation with KEMA	29
6. Multi Physics (MP) Simulation vs. Tensile Testing	29
National Electric Code [NEC] and Canadian Electrical Code	30
UL/CSA and Cable Cleats	31
SECTION 4: BEST PRACTICES AND TECHNICAL REFERENCE	32-38
Corrosion	32
Stainless Steel	33
Galvanic Corrosion	33
UV Degradation	34
Cable System Design.....	35
1. Rigid Cable System Design.....	35
2. A Flexible Cable System Design	35
The Role of a Cable Cleat During a Fire	36
Operating Temperatures	36
Panduit Cable Cleat Agency Approvals.....	37
Panduit Cable Cleat Team	38



Section 1: Short Circuit Faults – Protecting with Cable Cleats

Definition of a Short Circuit Fault:

A short circuit is a low resistance connection between conductors supplying electrical power to a circuit. This results in excessive current flow in the power source through a ‘short’. When a short circuit occurs, current in the system increases to an abnormally high value while the system voltage decreases to a low value. The short rapidly produces electromagnetic forces that send the cables violently repelling against each other that can damage equipment and injure or even kill personnel.

What happens when cable cleats fail during a short circuit?

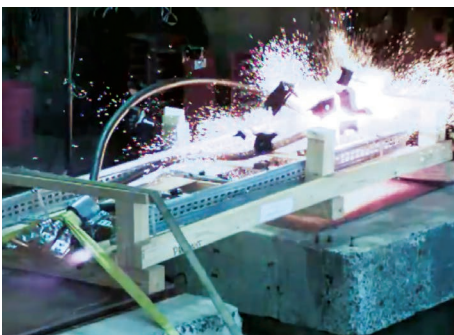

Fig. 1: Example of an intentional short circuit fault during testing

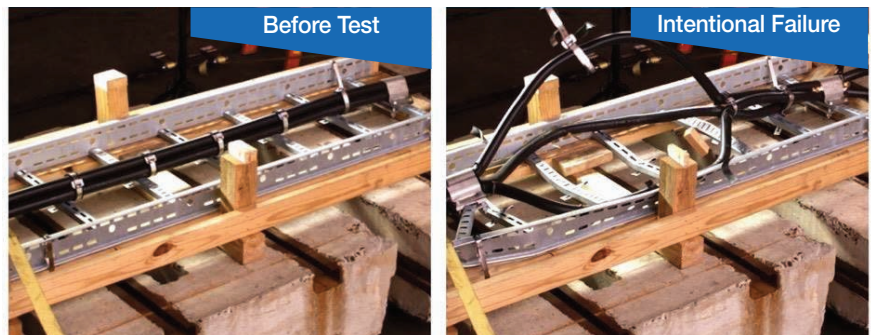

Fig. 2: Example of an intentional short circuit fault during testing: Before and After



Common Causes of Short Circuit Faults

A short circuit in the field is an accidental conductive connection between two or more points of a circuit. Electrical power cable failures usually culminate in a short circuit fault between phases and/or between phases and earth (ground). The first stage is that the electrical insulation breaks down. This process can be electrical or thermal degrading the insulation, however in many cases mechanical damage is the process that causes the insulation to breakdown resulting in a fault. Mechanical forces can act on a power cable both externally and internally and a cable can be subjected to mechanical forces at every stage throughout its life including:

- Manufacturing
- During storage prior to delivery
- Transportation to site
- During installation
- While in service

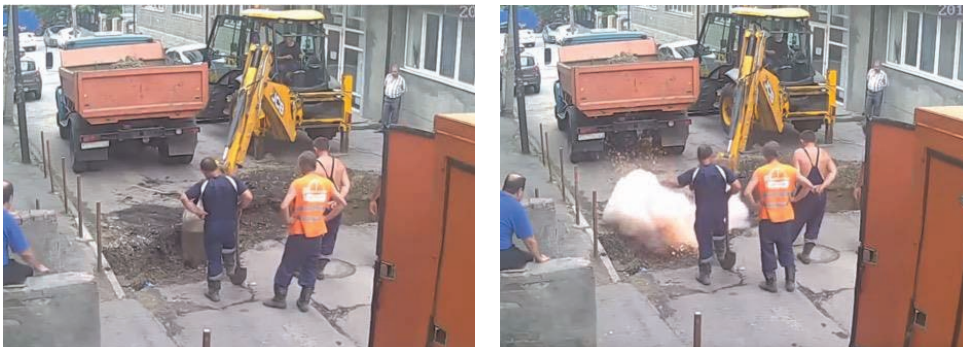

Fig. 3: Unintentional contact with power cabling resulting in a short circuit



Fig. 4: Examples of mechanical failure resulting in short circuit fault

Definition of a Cable Cleat

Although the International Standard does require the manufacturer to classify a material type, it also does not exclude any specific material, nor does it dictate any minimum dimensions or physical attributes. Annex A (informative) in the IEC cable cleat standard provides examples of various cable cleats which include products made from timber, steel, and plastic. There is a variety of designs and methods for 'securing cables', such as designs starting at 15mm wide to 150mm wide.

Defined by the IEC International standard, a cable cleat is simply:

“A device designed to secure cables when installed at intervals along the length of the cables¹”

Panduit Cleat Examples

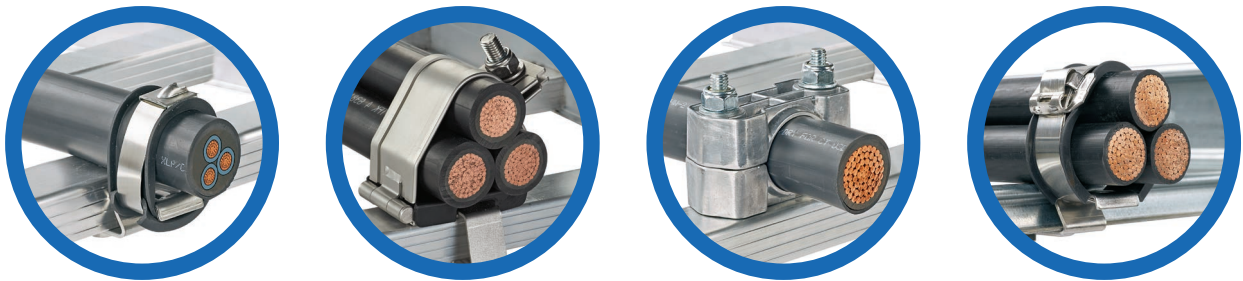

IEC 61914:2015 Examples



Fig. 5: Examples of Cleats

Timing of a Short Circuit Fault

One major element, which is often overlooked, is the duration of a short circuit. Often an installation specification reads e.g. “short circuit withstand of 1 second” which causes the engineer meeting this requirement.

If reference is made to Fig. 6, which shows the short circuit current of a generator short circuit with a constant a.c. component (fault far-from-generator), then (assuming a 50Hz cycle), we can see that 5 full cycles of the fault relate to only 0.1 second.

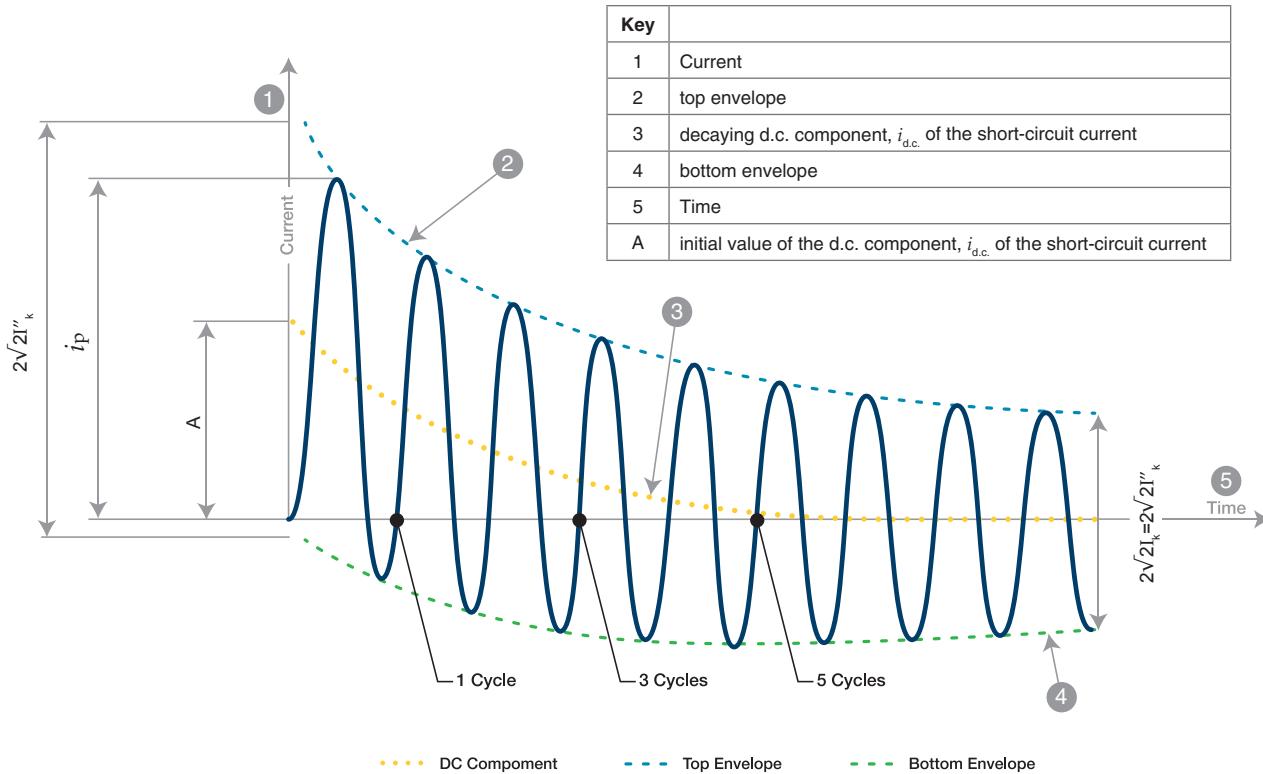
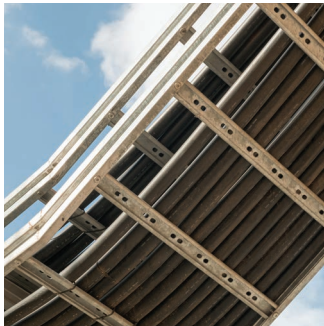

Fig. 6: Short Circuit Current Graph

Considering that the full force of the fault is seen at the peak (i_p) [Fig. 6: Short Circuit Current Graph] i.e. the first quarter cycle (0.005 seconds) it becomes clear that the 1 second, or in some cases a 3 second, requirement is irrelevant regarding the instantaneous electro-magnetic forces of a short circuit fault.



Examples of improper cable routing without cleats.



The one or three second figure is often quoted from a cable specification; this figure is the thermal withstand of the cable and considers conductor cross section and its ability to carry a level of current and therefore heat, for a period of time.

In summary, the figure given for one or three seconds does not relate to the actual peak value of the fault, and this often mis-quoted figure of 'short circuit withstand' is irrelevant to the electro-magnetic forces experienced during a fault.

It is possible however to subject a cable cleat to a prolonged short circuit, but the test will not follow the same characteristics of the Fig. 6 graph on page 7; the peak will not be as proportionally high and the RMS more uniform, rather than diminishing. This type of test is more to check that the cleat can cope the increased temperature of the outer jacket of the cable.



What We Know



Electromagnetic Force Peak Occurs at:
– **5 ms on a 50Hz system (0.005 sec)**
– **4 ms on a 60Hz system (0.004 sec)**



Cable Cleats perform their function immediately, **before peak kA is reached and before the fault protection devices can react and trip**



Circuit breakers and other protection devices trip at:
– **0.06 sec to 0.1 sec after 3-4 cycles with a fault**

The Necessity of Cable Cleats

Although there are several demanding tasks, one of the major requirements of a cable cleat is to protect people and equipment in the event of a short circuit on a cable system.

Electric currents in conductors, which are laid adjacent to one another, produce electro-magnetic fields between these conductors. During a short circuit fault, the electric current turns into a magnetic force and the highest repulsive force between conductors is proportional to the square of the peak short circuit current. This is then followed by a residual, pulsating, oscillating stress at a frequency of twice the operating frequency, known as the fault RMS. However, it is accepted that the forces at the peak of the fault are the highest, the most instantaneous, and in turn the most destructive, when considering system protection.

What We Know



What a cable cleat is - “A **device** designed to provide securing of cables when installed at intervals along the length of cables.”



What happens to cables during an actual three phase fault



Short Circuit Faults do happen out in the field, regardless of preventative measures



The timing involved during a fault (0.005s)

Key Takeaways

1

Cleats mitigate the impact of a short circuit before fault protection devices can react and trip

2

IEC 61914 standard ensures that cable cleats can withstand and protect during a short circuit event



Section 2: Cable Cleat Development Process

IEC 61914:2015 Cable Cleats for Electrical Installations

IEC 61914:2015 is the second version of the standard. The original was IEC 61914:2009. This IEC committee was formed by the previous European Standard BS EN50368:2003.

2009

Version did not specify range of cable diameters to use in the short circuit test

2015

Version standardized test cable diameter range

2015

Version specifies range of cable diameters that cable cleats need to be tested to 30 to 40 mm or 45 to 55 mm

Key Takeaway



Note: It is critical to select, specify and install cable cleats that are tested to the IEC 61914:2015 revision as the 2015 takes the subjectivity out of the peak current rating by standardizing the cable diameters for testing. Prior to the 2015 revision standard, cleat manufacturers could not be compared to each other on performance as there wasn't a cable diameter standard.

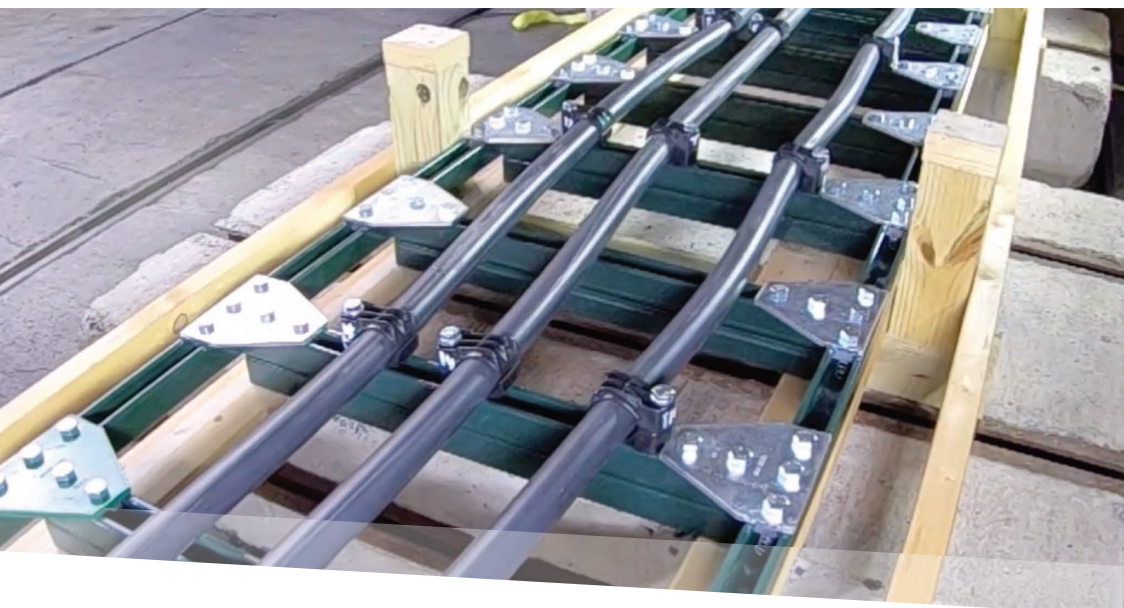
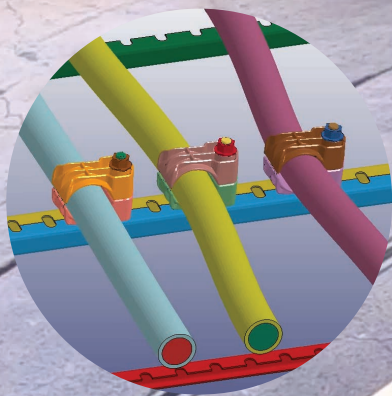

IEC 61914:2015 Cleat Testing Criteria

Provides testing parameters for:

- Temperature rating (-60°C to +120°C)
- Resistance to flame propagation (very similar to UL 94)
- Lateral load testing (at maximum declared temp)
- Axial load testing (at maximum declared temp)
- Impact resistance (at lowest declared temp)
- Corrosion and UV resistance
- Resistance to electromechanical force



Selecting and installing a Cable Cleats tested to IEC 61914:2015, provides the assurance and insurance the impact from a short circuit fault will be minimized.



IEC 61914:2015 Short Circuit Force Calculations

When the system peak fault current and the cable diameter are known, the following formula taken from the International Standard IEC 61914:2015, can be used to calculate the forces between two conductors in the event of a three-phase fault:

Cable Cleat Short Circuit Force Formula

$$F_t = \frac{0.17 \times ip^2}{S}$$

F_t = maximum force on conductor (N/m) **ip** = peak short circuit current (kA)

S = center to center distance between two neighboring conductors (m)*

*International Standard IEC 61914 Edition 2.0 2015-11

Please note: this formula only gives an estimate
and advice should be sought on specific installations

Fig. 7: Cable Cleat Short Circuit Force Formula

* For a trefoil formation this S is the cable outside diameter (OD)



1. Selecting Cable Cleats:

There are various considerations to ensure that the correct specification of a cable cleat is made properly. This will differ from site to site and include material type, ambient conditions, extreme temperatures, corrosive and aggressive atmospheres. The above-mentioned aspects are covered by the IEC standard but also a cleat manufacturer will have data sheets to prove compliance to most situations.

Specification of the correct cable cleats in regard to a short circuit fault withstand rating can be difficult and require manual calculations that contain multiple variables such as:

- **Cable Diameter**
- **Cleat Installation Spacing**
- **Peak Short Circuit rating**

Once F_t in N (see Fig. 7 on page 12) has been determined, then the force for a specific installation can be calculated per meter. Cable Trays often have rungs at 300mm intervals, so cleat spacing is usually a multiple of this distance. Therefore, $F_t \times 0.3$ gives the force a cleat will be subjected to if spaced at 300mm, $F_t \times 0.6$ for 600mm etc.

The resulting force at each rung interval can then be compared to the maximum recommended mechanical tensile loop strength of the cable cleat. The cleat type and spacing can then be specified to meet the requirements of the IEC standard.

2. Cable Cleat Calculation Example

$$i_p = 75.1 \text{ kA}$$

$$S = 38 \text{ mm or } 0.038 \text{ m}$$

$$F = \frac{0.17 \times 75.1^2}{0.038} = 25,231 \text{ N/m}$$

The force on each cleat is $F_t \times$ cleat spacing where “spacing” is distance between cleat fixings in meters. So, force on each cleat if spaced 300 mm apart is as follows:

$$F_t = 25,231 \times 0.3 = 7,569 \text{ N/cleat}$$

Key Takeaway



TIP: If the peak kA (ip) is unknown:

Often the peak kA (i_p) is not known and the RMS value is given. To calculate the peak current from the RMS a multiplier can be used ranging from 1.7 to 2.7 if this has been calculated. However, in the absence of a specific figure, ‘IEC 61439-1 Low voltage switchgear and control gear assemblies’ can be referred to, which uses the following multiples:

- An RMS of 10 - 20kA = 2
- An RMS of 21 - 50kA = 2.1
- An RMS greater than 51kA = 2.2

It is always preferred to have the actual Peak kA (i_p)



3. Simplifying the cleat specification process: The Panduit Cleat kAlculator™ App

To assist design engineers in specifying the correct cleat and spacing, Panduit has developed their own app. Available in the iOS and Android, once downloaded, the user can input information such as cable layout, cable diameter and peak fault level. Based upon the results of independent laboratory short circuit testing the Cleat kAlculator™ app will suggest a cleat type and recommend the correct cleat spacing. If there is more than one option to match the enquiry the app will offer a choice and the user can assess the benefits of each option. Results can also be saved on the device and emailed.



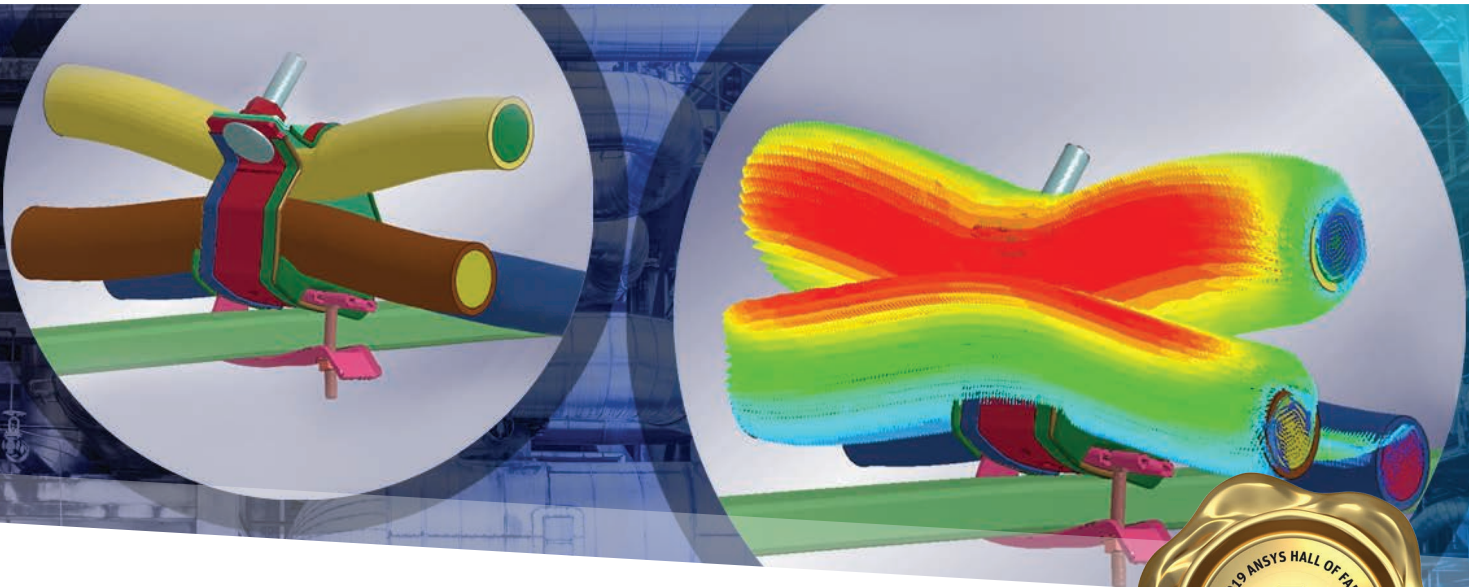

Panduit Cleat Development Process

To support the engineering design of safe, reliable, and high performing cable cleats, Panduit has utilized a Finite Element Analysis (FEA) software platform to develop a model simulating the dynamic forces of a short circuit fault. Panduit continues to utilize the algorithms and software to model short circuit forces on ongoing client projects providing robust and reliable cleat solutions.

Panduit's engineers modeled an award winning, highly dynamic, multi-body contact, 3-phase alternating current short circuit test. Significant simulation development milestones included:

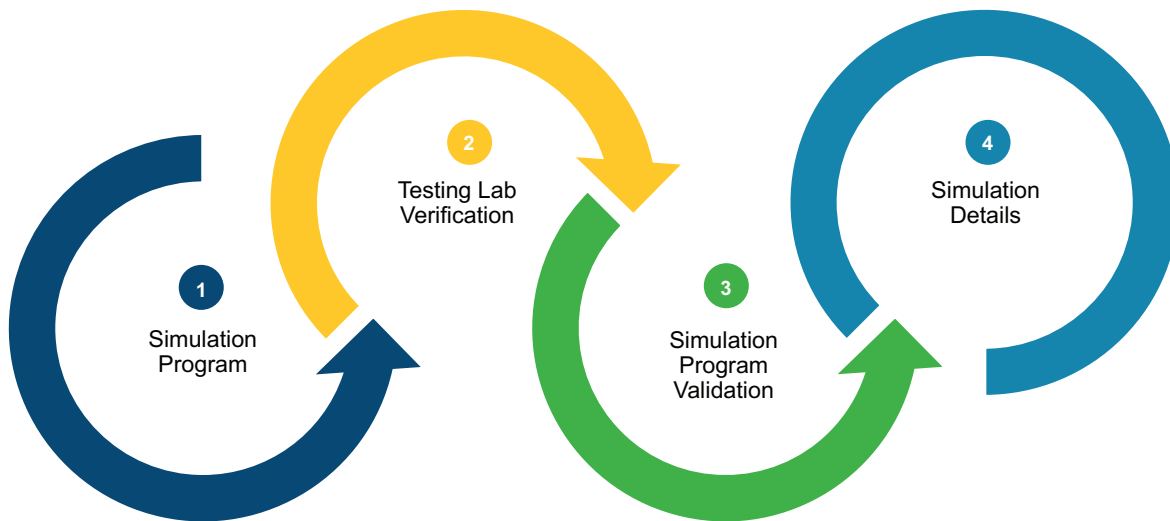

1. Adjusting the stiffness, yield strength, and mass of solid copper conductors to behave like stranded conductors at the prevailing temperatures
2. Developing high strain-rate material models for each component
3. Integrating the electro-magnetic solution capability into the simulation
4. Development of a 30-variable mathematical model to exactly match the short circuit test current pattern and using a genetic algorithm to find the variable coefficients
5. Developing element erosion criteria to enable simulation of physical failure
6. Successful verification in early testing

The Panduit cable cleat product lines were originally certified in testing near the peak short circuit current levels predicted by the simulation. The understanding of the variables involved in the 3-phase short circuit event, repeated simulations to verify design changes and predict peak current certification levels in testing, resulted in a substantial reduction in design and successful IEC approval.

The FEA model can also be used at early stage of project to analyze the cable, tray cable and cleats as system under the peak current load requirements of the power system. This drastically reduces project design time and provides assurance that the correct cleat is specified.

Match KEMA Short Circuit Test Pattern

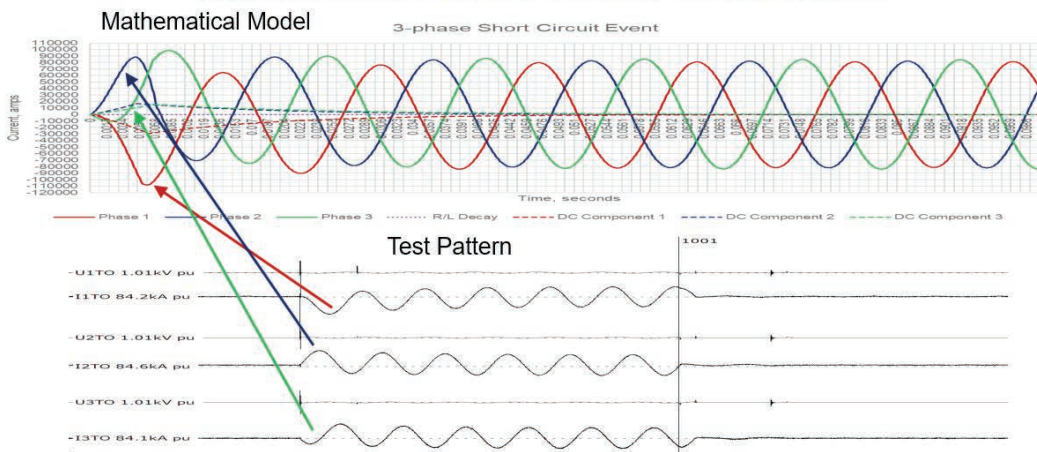

Key Takeaway



Cleat spacing is critical to a properly engineered solution



Section 3: Cable Cleat Standards and Technical Forefront: IEC 61914:2015 – Testing Methodology

NOTE: Excerpts are taken from IEC 61915:2015 for illustrative purposes only to highlight the importance of the standard and its criticality of the standard to safe and reliable cleat design. This is not the full standard in its entirety and should not be used for testing compliance cable cleats. IEC 61914:2015 is the property of the IEC organization and can be purchased at: webstore.iec.ch

In the next few pages the IEC 61914:2015 standard will be explored at a high level outlining the methodology and testing criteria to successfully design and test a cable cleat to meet standard requirements as well as the appropriate methodology to correctly specify a cleat system in the protection against a short circuit fault.

The standard provides harmonized testing procedures and declarations for the following aspects:

1. **Temperature rating (-60°C to +120°C)**
2. **Resistance to flame propagation (very similar to UL 94)**
3. **Lateral load testing (at maximum declared temp)**
4. **Axial load testing (at maximum declared temp)**
5. **Impact resistance (at lowest declared temp)**
6. **Corrosion and UV resistance**
7. **Resistance to electromechanical forces**



1. Temperature Rating (-60°C to +120°C)

Minimum Temperature °C
+ 5
- 5
-15
- 25
- 40
- 60

Maximum Temperature °C
+ 40
+ 60
+ 85
+ 105
+ 120



2. Lateral Load Testing (at maximum declared temperature)

Compliance is checked by the following test:

- The cleat is mounted on a test rig as shown in the Fig. 8 below, or a similar arrangement. The mounting surface can be made of steel or aluminum plate, plywood or other material.
- For metallic cable cleats, the declared load is applied gradually and held for a period of (60 +5/0) minutes.
- For non-metallic and composite cleats, the sample assembly is placed in a full draft air-circulating oven. The tests are carried out after the oven temperature has reached and maintained the declared maximum temperature from Table 1 with a tolerance of (+2/-2) °C. The load is applied gradually and then held for a period of (60 +5/0) minutes.

A cable cleat intended for a single mounting orientation shall be tested in that orientation and that orientation shall be declared in the documentation. A cable cleat intended for multiple mounting orientations shall be tested in each mounting orientation using separate samples.

Key	
1	cleat
2	mandrel
3	direction of load
4	mounting surface

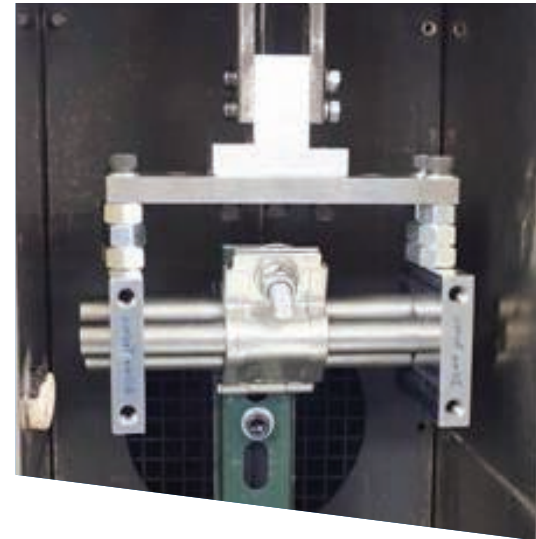
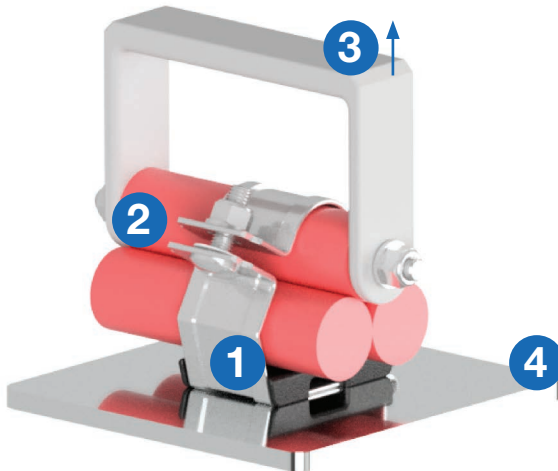

Fig. 8: Testing of Cleat Lateral Load- Panduit Lab Test Setup

3. Axial Load Testing (at maximum declared temp)

The test is carried out using a mandrel with an overall cross section equivalent to the minimum declared cable cross section for which the cleat is designed. The test mandrel shall have a diametrical tolerance of (+0.2/-0.2) mm for mandrels up to and including 16 mm diameter and of (+0.3/-0.3) mm for larger diameters.

- In the case of non-circular cables, a profile is to be used simulating the outer cable dimension, as declared by the manufacturer or responsible vendor.
- For cleats and intermediate restraints taking more than one cable, the appropriate number of mandrels is used. Where more than one mandrel is used the load shall be simultaneously applied to all mandrels. All mandrels shall have a surface roughness less than or equal to $7 \mu\text{m Ra}$ in accordance with ISO 4287.
- For test temperatures below 105°C , test mandrels may be solid polyamide or metal. Metallic mandrels shall be used for test temperatures 105°C and higher. The cleat is mounted on a rigid mounting surface and assembled in the test rig as shown in Fig. 9 below, or a similar arrangement. The mounting surface can be made of steel or aluminum plate, plywood or other material.
- For metallic cable cleats, the declared load is applied gradually and held for a period of $5 (+1/0)$ min.
- For non-metallic and composite cleats, the sample assembly is placed in a full draft air-circulating oven. The tests are carried out after the oven temperature has reached and maintained the declared maximum temperature from Table with a tolerance of $(+2/-2)^\circ\text{C}$. The load is applied gradually and held for a period of $(5 +1/0)$ min.

After the test, the displacement of the mandrel(s) with respect to the cleat shall not be more than 5 mm.

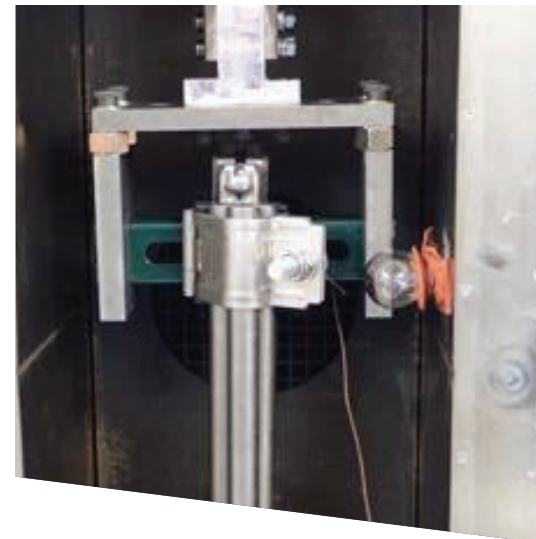
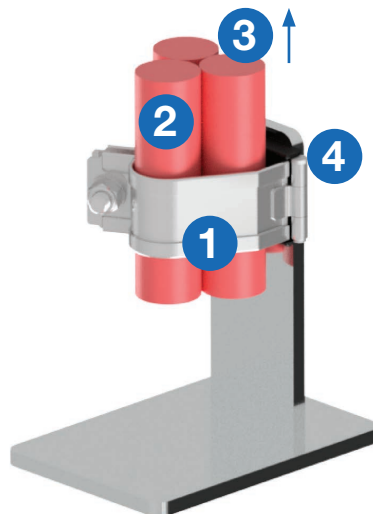

Fig. 9: Testing of Cleat Axial Load- Panduit Lab Test Setup

Key	
1	cleat
2	mandrel
3	direction of load
4	mounting surface



4. Impact Resistance (at lowest declared temperature)

Before the test, the samples are assembled onto a solid polyamide or metal test mandrel having a diameter equivalent to the maximum declared diameter for which the cleat is designed and mounted on a rigid support.

- For cleats and intermediate restraints taking more than one cable, the appropriate number of mandrels is used.
- For metallic cleats and intermediate restraints, the test is carried out at ambient temperature.
- For composite and non-metallic cleats and intermediate restraints, the samples are conditioned at the declared lowest temperature according to Table 2 with a tolerance of (+2/-2) °C for a period of (60 +5/-0) min.

The impact is applied within a period of (10 +0/-2) s after removal from the refrigerator. Each sample is placed in position on the steel base as shown in Fig. 10. The energy value of the hammer is as declared in table.

The impact is applied at the weakest point of the cleat or intermediate restraint and the direction of impact is radial to the center of the mandrel nearest to the point of impact. After the test, the samples shall show no signs of disintegration nor shall there be any cracks or damage, visible to normal or corrected vision, that are likely to impair normal use.

Classification	Nominal Impact Energy J	Equivalent Mass kg ($\pm 2\%$)	Height mm ($\pm 1\%$)
Very Light	0.5	0.25	200
Light	1.0	0.25	400
Medium	2.0	0.5	400
Heavy	5.0	1.7	300
Very Heavy	20.0	5.0	400

Key	
1	hammer
2	fail height (see Table)
3	rigid steel base
4	sample

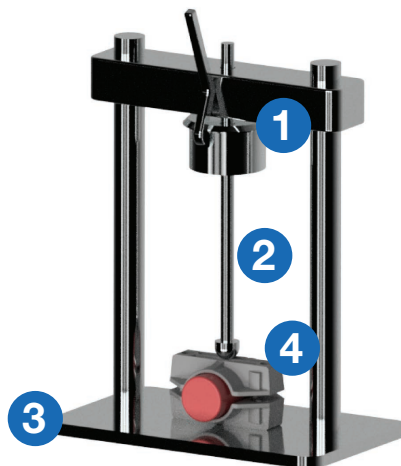

Fig 10: Testing of Impact Resistance Test- Panduit Lab Test Setup

4. Impact Resistance at Lowest Declared Temperature (continued)

Panduit Stainless Steel Trefoil Cable Cleats pass the Very Heavy Classification of the Impact test in Section 9.2. The spacer material passes the flame test per Section 10.1. Axial and Lateral Pulls provide a load and are not pass or fail tests. Actual situations in axial and lateral pull will vary greatly with changes in cable diameter, temperature, and cable jacket material.



5. Corrosion Resistance

Metallic or composite cleats and intermediate restraints shall have adequate resistance to corrosion. Compliance is determined by conducting a salt spray test unless otherwise specified.

6. Salt Spray Test

All grease shall be removed from the parts prior to testing by cleaning with white spirit. All parts shall then be dried and samples assembled on a nylon mandrel with a diameter equal to the smallest cable diameter declared for the cleat or intermediate restraint. Samples shall be subjected to a neutral salt spray test according to ISO 9227. After the parts have been dried for a minimum of 10 min while heated in a cabinet reaching 100 (+/- 5) °C. Any traces of rust on sharp edges and a yellowish film may be removed by rubbing. The sample shall have passed the test if there is no red rust visible to normal or corrected vision. Zones that trap saltwater during the test are not considered for the test result.



Fig. 11



Fig. 12



Fig. 13



Fig. 14

7. UV Resistance

When the product is provided in more than one color, the color having the heaviest organic pigment loading shall be subjected to this test. The samples tested are considered representative of the entire color range. Samples shall be mounted in the ultraviolet light apparatus in a convenient manner suitable for the product to be tested. Samples should not touch each other. The samples are to be exposed for a minimum of 700 h to Xenon-arc, Method A, Cycle 1 in accordance with ISO 4892-2:2006. There shall be continuous exposure to light and intermittent exposure to water spray.

The cycle consists of 102 min without water spray and 18 min with water spray. The apparatus operates with a water-cooled xenon-arc lamp, borosilicate glass inner and outer optical filters, a spectral irradiance of 0.51 W/(m²•nm) at 340 nm and a black-standard temperature of 63°C. The temperature of the chamber is 38.3°C. The relative humidity in the chamber shall be 50%. Following the exposure, the samples are held for a minimum of 30 min under ambient conditions. After UV exposure, the samples showing no signs of disintegration nor any cracks or damage, visible to normal or corrected. The samples will then be subjected to the impact test, described above and shall comply with the impact test requirements.

8. Resistance to Electromechanical Forces – The Ability to Withstand One Short Circuit Event or Two Short Circuit Events in Succession

A short-circuit test is carried out as follows, using the manufacturer’s or responsible vendor’s declared values of peak short-circuit current (ip) and initial r.m.s. symmetrical short-circuit current. One set of cleats of each type and of a size suitable for the test cable shall be tested.

The test is performed using unarmored single core 600 V / 1000 V stranded copper conductor cable of either (35 +5/-5) or (50 +5/-5) mm diameter.

The test is carried out at the prevailing ambient temperature on the declared arrangement at the declared short-circuit level. The ambient temperature shall be recorded in the test report. Typical assemblies are shown in the following figure:

Key	
1	connection
2	cable cleats
3	mounting surface
D	spacing

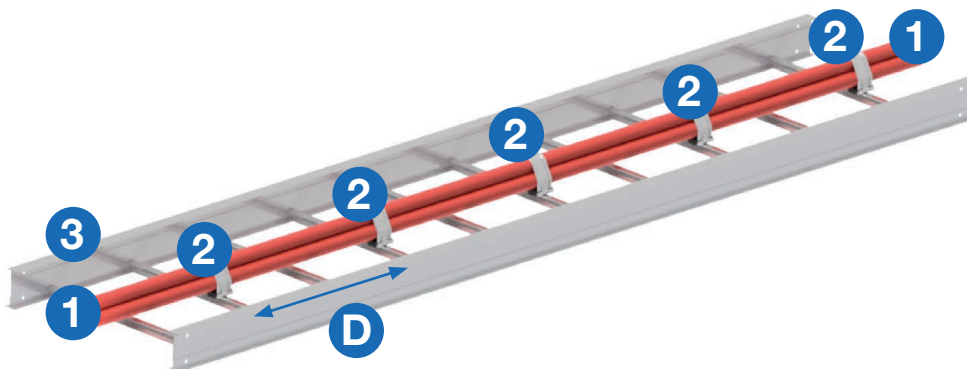

8. Resistance to Electromechanical Forces – The Ability to Withstand One Short Circuit Event or Two Short Circuit Events in Succession (continued)

The arrangement of the cables can be true touching trefoil or flat, spaced formation with one cable per phase. One end of the cable is connected to a three-phase supply and the other end to a short-circuiting busbar with all three phases being connected. The short-circuiting busbar shall be insulated from earth.

The cable is restrained at a minimum of 5 positions along the cable run. Where intermediate restraints are used, at least 4 cleats and at least 3 intermediate restraints shall be used. Cleats and intermediate restraints, where used, shall be equally spaced. The cleats are fixed to a mounting surface defined by the manufacturer (e.g. cable ladder) which shall be selected regarding the forces likely to occur during the test.

Care is taken to ensure the cross-sectional area of the cable is adequate for the magnitude and duration of the test current which shall be chosen so that the thermal stress rating of the cable used is not exceeded.

The test report shall contain the following information:

- **The manufacturer's or responsible vendor's catalog references of the cable cleat and intermediate restraint (where used);**
- **Assembly details showing:**
 - **Number of cleats and their spacing**
 - **Number of intermediate restraints (where used) and their spacing**
 - **The cable center spacing**
 - **Cable conductor diameter, insulation thickness, external diameter and markings**
 - **Pre-test photograph of the test assembly and a post-test photograph documenting the condition of the cable cleats, and intermediate restraints if used**
 - **The test duration**
 - **The ambient temperature during the test**

If the test station must undertake a calibration test, action is taken to ensure that the test installation is not affected. The cables of the test arrangement are subjected to a three-phase short circuit of duration of not less than 0,1 s. The duration of the test is recorded. Care must be taken to ensure that there is adequate restraint for the cables at each end of the cable run to be tested.

For cable cleats and intermediate restraints classified for one short circuit:

Cleats and intermediate restraints shall comply with the following requirements:

- **No failure that will affect the intended function of holding the cables in place**
- **The cable cleats and the intermediate restraints, if used, shall be intact with no missing parts including all devices used to secure the cleats to the mounting surface**
- **No cuts or damage visible to normal or corrected vision to the outer sheath of each cable caused by the cable cleats or by the intermediate restraints, if used.**

For cable cleats and intermediate restraints classified for two short circuits:

Cleats and intermediate restraints shall comply with the inspection after the first and after the second short-circuit applications. After a second short-circuit application, a voltage withstand test is performed by applying a minimum test voltage of 2,8 kV d.c. or 1,0 kV a.c. for a period of (60 +5/0) seconds according to the provisions of IEC 60060-1:2010, Clause 5.

The voltage withstand test is administered between the cable cores, which should be connected including the mounting frame. The mounting frame shall be bonded to the earthing system. The cable jackets and mounting frame be pre-wetted with enough water to facilitate a current leakage path along the outer jacket for (2 +1/0) mins before the test begins. The cables meet the requirements of the voltage withstand test without failure of the insulation.

When specifying cleats always make certain they are to the latest IEC 61914 standard and request a Published Lab Report (PLR) from the cleat manufacturer to validate performance.

Multi Physics Simulation vs. IEC Short Circuit Force Calculations

Panduit proud to have position on the IEC 61914:2015 standards committee and is currently using its Corporate R&D facility to review the Ft force formula used by the cleat industry. As technology has advanced and FEA simulations tools have become more cost effective and readily available, Panduit is exploring the dynamic impact of the short circuit fault not captured by the Ft force formula.



IEC 61914:2015

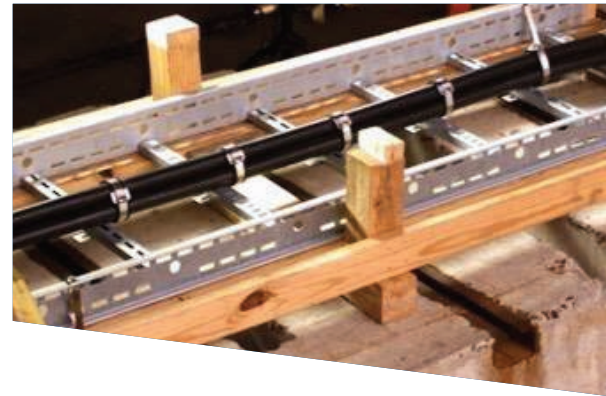

Typical Cable Formations

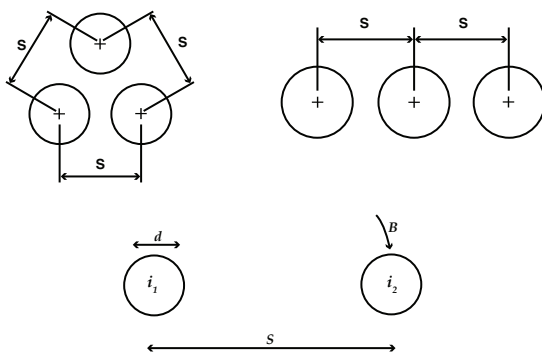

F_{fo} – Force on outer conductor in Flat Formation

$$F_{fo} = 0.16 * i_p^2 / S \quad (B.5)$$

F_{fm} – Force on middle conductor in Flat Formation

$$F_{fm} = 0.16 * i_p^2 / S \quad (B.5)$$

F_t – Force on conductor in Trefoil Formation

$$F_t = 0.17 * i_p^2 / S \quad (B.7)$$



1. Assumptions in IEC 61914:2015

Assumption 1: 'S' is assumed to be a constant for the entire length during short circuit event

- a) As cables move apart due to the EM forces, the distance between cables, 'S', increases and as a result, forces decrease due to deformation and elongation of cable. By using the static formula, we are overestimating the forces between the conductors while missing other key aspects of cable behavior.
- b) Furthermore, cables are considered to be rigid bodies with no flexing about its axis. During the short circuit event, cables flex and hit the cable cleats at different angles creating bending moments and resultant forces on the cleats.

Assumption 2: No multiple impacts between the cables and cable cleats

- a) By using the static formula, we ignore the impact of the cables hitting cable cleats multiple times which would cause accumulated damage, crack propagation and eventual failure.

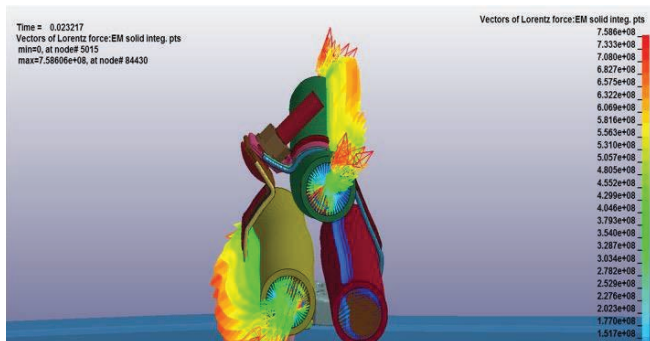

Fig. 15: Magnetic Force Vector Simulation

2. Force During a Short Circuit Event

- a. Lorentz force density plot shown opposite illustrates that force along the length of the cable is not constant but varies with maximum value near the cleat and decreases towards the midspan of cleat spacing.
- b. As a result, the total force on the cable along the length of cable could be lower than the forces calculated from the formula.
- c. By simply multiplying the force calculated from the formula with the cleat spacing under the assumption that F/m is constant along the cable length, the forces are overestimated.

If the actual forces are lower than the forces calculated from the formula and the cable cleats fails, what is missing?

The IEC Force Formula doesn't capture the following:

1. High strain rate
2. Dynamic nature of the cable behavior
3. Accumulated damage due to repeated impact
4. Connection method of cleat to cable tray / ladder / basket
5. Cable:
 - a) Type and construction
 - b) Temperature
 - c) Stiffness
 - d) Weight
6. Laboratory set up and connection method feeding the power to the test setup
7. Type of structure the cleats are fastened to e.g. cable tray / ladder / basket including material type

3. High Strain Rate

- a. Loading conditions depicted in the IEC standard formula is applicable for quasi-static conditions. At these loading conditions, the effect of acceleration and inertial forces are negligible with strain rates typically 0.01 s⁻¹.
- b. Strain rates experienced during short circuit events are much higher as can be seen from strain rate plot of the cleat. The effects mentioned above have a huge impact on the material behavior.
- c. As shown in the stress-strain curve, the failure point is reduced considerably due to high strain rate.
- d. High strain rates seen in cleats are typical for explosions and need sophisticated analysis to capture all aspects of material behavior rather than focusing on the force calculation

Application	Symbol.1., s ⁻¹
Storage tanks, pressure vessels	10 ⁻⁶ to 10 ⁻⁴
Bridges, cranes earthmoving	10 ⁻² to 0.1
Earthquake loading Marine collisions	0.1 to 10
Land transport, aircraft undercarriage	10 to 1000
Explosion, ballistics	10 ⁴ to 10 ⁶ plus

Maximum localized strain rate" ~2.06E4S -1

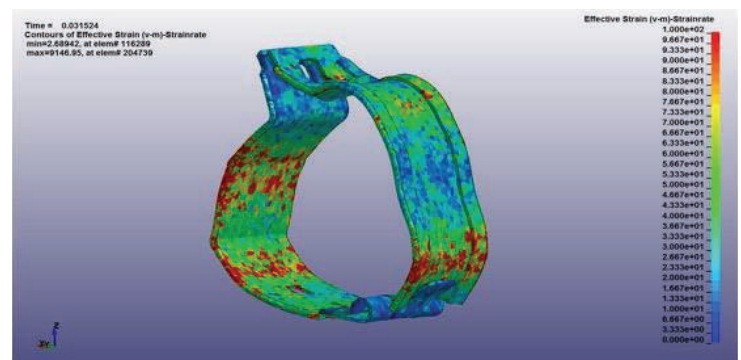
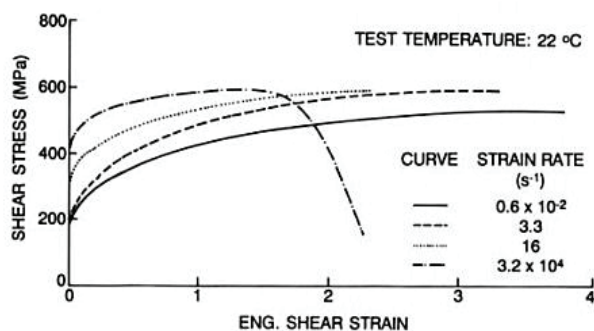

Fig. 16: strain rate plot of the cleat during a short circuit



*<https://icme.hpc.msstate.edu/>



4. Dynamic Behavior of Cable

- a. Cables do not just move up and down as a rigid body like it is simplified in the IEC standard. Dynamic transient loading events are observed during the short circuit event which is not captured in the IEC formula.
- b. During the short circuit, the cables react in violent fashion with cables moving in different directions at very high velocities as shown in the velocity plot on the right.
- c. As a result, cleats not only experience forces in the vertical direction but also at various angles while also creating bending moments on the cleat.

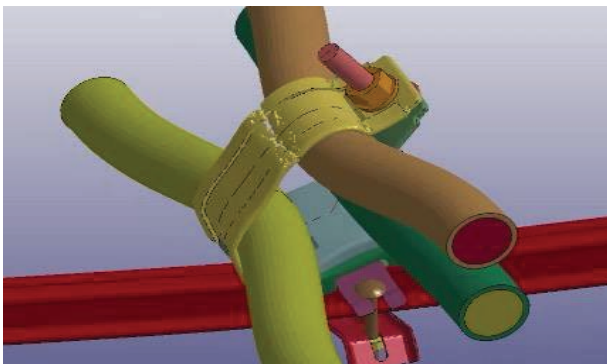

Fig. 17: Accumulated Damage from Repeated Impact of cable on cleats during a Short Circuit Fault

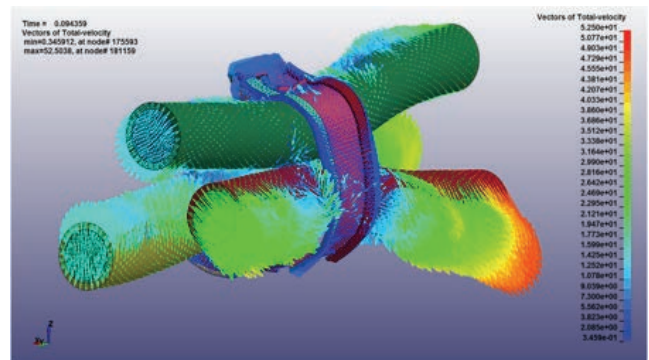

Fig. 18: Dynamic transient loading events are observed during the short circuit event which is not captured in the IEC formula

5. Validation of Multi-Physics Simulation with KEMA

1. FE Model of a cable cleat was analyzed using both the formula in IEC standard and by using Multi-physics (MP) simulation.
 - a) Static simulation model based on IEC standard predicted to pass at a higher KA value based on IEC formula
 - b) However, the same cable cleat analyzed using MP predicted to pass at a lower KA value.
 - c) Cable cleat was tested at KEMA and the cleat was certified at the KA value predicted by the MP Simulation
2. This proves that a simplified formula to validate cable cleat doesn't capture the material behavior in its entirety.

6. Multi Physics (MP) Simulation vs. Tensile Testing

Tensile testing and MP Simulation were conducted on a plastic trefoil cleat and validated with KEMA testing

1. Tensile testing was conducted first and rated the cleat at 155KA (Fig. 19)
2. MP simulation was carried at 155KA and failed as shown in (Fig. 20)
3. MP simulation predicted a passing KA value of 130KA for the cleat (Fig. 21)
4. Cable cleats were tested at KEMA at KA values predicted by Tensile testing and MP simulation
 - a) Cleats failed as shown in Fig. 22 (same failure mode as in simulation) at Tensile test KA values (155KA)
 - b) Cleats passed and got certified at KA values (130KA) as predicted by MP simulation
5. This experiment again proves that MP simulation is far superior to using IEC formula and widely used tensile testing method.

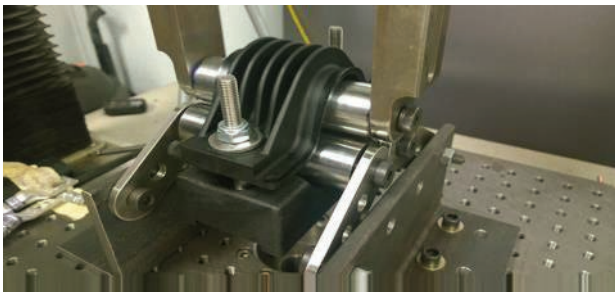

Fig. 19



Fig. 20

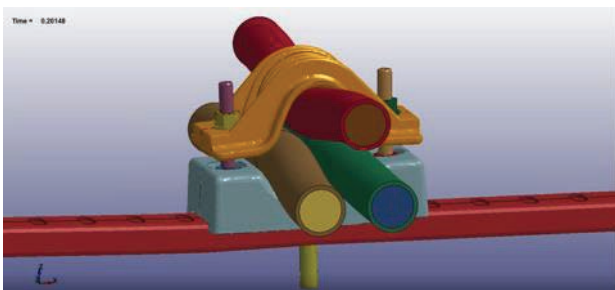

Fig. 21



Fig. 22

Tensile testing vs. FEA for Short Circuit Simulation

1. Cable cleat installations are often specified using tensile testing results and extrapolation to validate designs and publish load ratings of cleats
2. However tensile testing does not factor in the following:
 - a) Tensile tests doesn't take into account high rate of loading (~0.03in/sec vs >2,000 in/sec)
 - b) Strain rate of ~0.01s⁻¹ is used in tensile testing vs 2E4s⁻¹ (explosion level dynamic loading) typical during short circuit
 - c) Doesn't capture the repeated impact of cable with cleat and resulting accumulated damage
 - d) Doesn't take into account the cable contacting the cleat at different angles rather than uniaxial loading in tensile tests

Panduit will continue to collaborate with the IEC standards committee in the industry for the betterment of the cleat development and specifications process to ensure cable cleats protect the infrastructure and personnel from risks that occur during a short circuit fault.

National Electric Code [NEC] and Canadian Electrical Code

USA: NFPA 70 (National Electrical Code) NEC

Article 392.20(C) states:

"Parallel connected single conductor cables shall be securely bound in circuit groups to prevent excessive movement due to fault current magnetic forces."

Article 370.2 states:

"Cablebus, an assembly of units including insulated conductors.... This assembly is designed to carry fault current and to withstand the magnetic forces of such current."

Canada: C22.1 (Canadian Electrical Code) CEC Article 12-2202(5a) states:

"Conductors and cables installed in cable tray shall be fastened...at intervals of not more than 1.5 m throughout the run where excessive movement may be caused by fault current magnetic forces."

Article 131.5 states:

"Electrical equipment, including conductors shall be provided with mechanical protection against electromechanical stresses of fault currents as necessary to prevent injury or damage to persons, livestock or property."

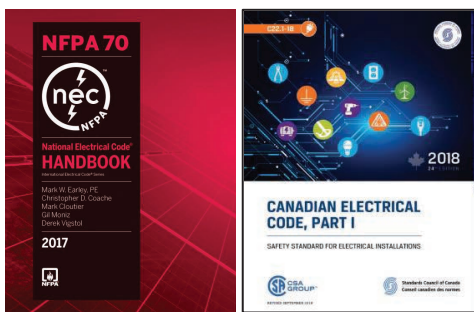

NEC / CSA indicates cables shall be restrained against electromagnetic forces but does not specify the how to restrain them or how to ensure the 'restraining device' will withstand a shot circuit fault. The IEC 61914 standard fills in the 'gaps' in the NEC/CSA codes ensures that the cable cleats used will provide protection during a short circuit event.

Both NEC and CSA reference the importance of protecting against the electromagnetic forces of a short circuit fault, neither specify how to properly design, test or install a cleat system to meet those requirements. The IEC 61914 standard replaces the ambiguity in the NEC/CSA codes by providing the assurance and insurance that cables will meet the protection requirements during a short circuit fault.

UL / CSA and Cable Cleats

As noted above both NEC and CSA do not specify the use of cable cleat it should also be noted that UL does not have a specific standard to which cable cleats are tested and approved to.

- Closest applicable standard is UL 2239 “Hardware for the Support of Conduit, Tubing, and Cable”
- Focused on mechanical support not short circuit
 - Testing is concentrated on a lateral pull test
 - UV testing
 - Stress relief for molded components
 - Fire and Flame testing

All Panduit Cleats are CULUS listed to UL 2239



Key Takeaways

1

A comprehensive simulation model using Multi-Physics and precise loading algorithm is essential to accurately depict cable behavior and resultant cleat deformation.

2

NEC and C22.1 references that cables shall be bound to prevent movement during a short circuit fault but doesn't specify the how. The IEC 61914 cleat standard fills the gaps in the NEC/C22.1 codes for cleat specification and performance.



Section 4 – Best Practices and Technical Reference

Both the IEC calculation method and the Cleat kAlculator™ app method allow the design engineer to specify a cleat when the cables are laid flat in a horizontal orientation. However, when the cables are installed vertically the self-weight of the cable must also be considered and this gravitational force will need to be catered for as well as the short circuit requirement.

Regardless of calculation values it is recommended that an absolute maximum lineal spacing of 1200mm is adhered to. Panduit also recommends that when cables are installed around a 90° bend or a 90° riser, then the cables should be restrained at every rung.

Corrosion

A major issue to consider when specifying cable cleats is the risk of corrosion. This can arise not just as a result of the environment affecting the cleat components and structure, but also as a result of bi-metallic corrosion between the cleat and the structure to which it is fastened.

Few metals will suffer corrosion damage in a dry, unpolluted atmosphere at a normal ambient temperature. Unfortunately, such environments are exceptional and atmospheric pollutants as well as moisture, in the form of rain or sea water, is likely to be present to some degree in most situations, thus some chemical corrosion may be expected in almost all situations.

Any cleat installation situated in an area where higher concentrations of chemicals exist must be subject to more detailed consideration to select an appropriate material which provides the best combination of initial cost and expected life.

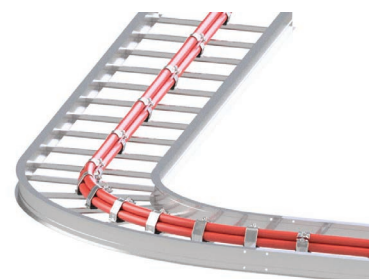

Stainless Steel

Panduit's Stainless Steel Buckle Strap Cleat and the Stainless Steel Trefoil Cleat range are made from 316L stainless steel. This material offers excellent corrosion resistance and its non-magnetic properties ensure that magnetic eddy currents are not an issue when used to fasten single core conductors.

For most practical purposes stainless steel can be regarded as maintenance and corrosion. Inevitably there is a relatively high price to pay for these attractive properties but, in aggressive environments or where the cost and inconvenience of gaining subsequent maintenance access is prohibitive, this initial cost premium may well be justified.

Stainless steel contains a high proportion of chromium (usually at least 11%) and the materials remarkable immunity to corrosive attack is conferred by the chromium-rich oxide film which occurs naturally on its surface. This invisible film is not only inert and tightly bonded to the surface; it also re-forms quickly if the surface is damaged in any way.

The Panduit range of stainless products are manufactured from 316L stainless steel which contains 18% chromium. Many grades of stainless steel are available but the one generally used in aggressive marine environments is Grade 1-4404 (equivalent to 316L). This grade has improved corrosion resistance (particularly in the presence of chlorides) and high temperature strength. It is often used in the chloride-laden marine conditions which exist on offshore installations and in coastal regions.

A stainless steel surface will have excellent corrosion resistance due to the chromium oxide layer on the surface of the product. However, with some stainless steel, the surface areas can become subject to corrosion due to the depletion of chromium during welding. If a stainless steel product has been welded, then all weld spatter must be removed with a suitable wire brush. This improves the appearance of the weld but perhaps more importantly removes any residue which may affect the long-term corrosion resistance of the stainless steel.

Galvanic Corrosion

Bi-metallic, or Galvanic corrosion is an electrochemical process. It occurs as a result of very small electric currents flowing between two dissimilar metals which causes the more anodic of the two metals to corrode, the more noble or cathodic metal being unaffected. The current flows as a potential difference and exists between the two pieces of metal in the presence an electrolyte such as moisture at the contact point. Since most corrosion is an oxidation process, the existence of a steady supply of oxygen at the surface of the metal is also necessary for corrosion to occur.

In an atmospheric environment the level of bimetallic corrosion will be low if the ratio of the surface areas for anodic and cathodic metals is low and/or if the frequency or period of dampness (e.g. presence of an electrolyte) is low. Conversely if different metals are immersed in an electrolyte of increased conductivity such as sea water the level of bimetallic corrosion will be substantially greater. While immersion in fresh water, which is less conductive than sea water, would have a more significant effect than open atmospheric exposure, it would be less detrimental than immersion in sea water.

Metal Corroding	Contact Metal													
	Magnesium & alloys	Zinc & alloys	Aluminum & alloys	Cadmium	Steel-carbon	Cast iron	Stainless steels	Lead, tin and alloys	Nickel	Brasses, nickel silvers	Copper	Bronzers, cupro-nickels	Nickel copper alloys	Nickel-Chrome-Mo Alloys Titanium, silver, graphite Graphite, gold, platinum
Magnesium & alloys	X	X	X	X	X	X	X	X	X	X	X	X	X	X
Zinc & alloys		X	X	X	X	X	X	X	X	X	X	X	X	X
Aluminum & alloys			X	X	X	X	X	X	X	X	X	X	X	X
Cadmium				X	X	X	X	X	X	X	X	X	X	X
Steel-carbon				X	X	X	X	X	X	X	X	X	X	X
Cast iron					X	X	X	X	X	X	X	X	X	X
Stainless steels					X	X	X	X	X	X	X	X	X	X
Lead, tin and alloys						X	X	X	X	X	X	X	X	X
Nickel									X	X	X	X	X	X
Brasses, nickel silvers						X	X	X	X	X	X	X	X	X
Copper							X	X	X	X	X	X	X	X
Bronzers, cupro-nickels											X	X	X	X
Nickel copper alloys													X	X
Nickel-Chrome-Mo Alloys Titanium, silver, graphite Graphite, gold, platinum														X

X = Galvanic Corrosion Risk

With reference to the table above, when a stainless steel cable cleat is fastened to a carbon steel structure, and the possibility of moisture (rain) is present then bi-metallic corrosion is a potential threat and correct engineering practices should be considered. A galvanized structure would help to alleviate the issue but over time the zinc coating of a galvanized structure can be eroded itself and then the previous problem exists. When considering a cleat installation Panduit will always plan for this possibility of long-term damage and help the client to specify the correct products, and if necessary, provide insulation washers and sleeving.

UV Degradation

Exposure to sunlight and some artificial lights can have adverse effects on the integrity and the durability of polymer cable cleats. UV radiation can break down the chemical bonds in a polymer. This process is called photodegradation and ultimately causes cracking, chalking, color changes and the loss of physical properties such as impact strength and tensile strength which are vital to the performance of a cable cleat.

In a polymer cable cleat, UV Degradation takes place for two reasons:

- 1. Polyolefins absorb UV light for several reasons for example due to impurities present in the polymer, oxidation products formed during processing or additives and pigments used in the formulation of the finished molding.**
- 2. Some polymers like engineering plastics and rubbers absorb UV-light because of their intrinsic chemical structure (e.g. Polystyrene, Polyesters, etc.).**

In addition to the effect of UV radiation, the general weathering of plastics can occur over time and can be a result of various factors such as ambient and extreme temperatures, precipitations and other external environmental contaminants.

To counteract these damaging effects on the long-term performance of the polymer, a broad range of UV stabilizers are available and where appropriate are used throughout the Panduit range of cable cleats.

Cable System Design

1. A Rigid Cable System design

In a rigid installation system, the cables and accessories are fixed in such a way that thermal expansion and contraction do not lead to significant movements. A rigid installation is generally achieved when cables and joints are directly embedded in well compacted ground. The burial depth needs to be sufficient so that cable cannot push up the backfill. The conditions of the soil are to be taken into consideration.

However, if for example due to confined space, or burial is not possible, and a rigid installation is installed in open air then the cables should be cleated at short intervals. Joints and terminations should also be protected and rigidly fixed.

During operation the cable will be heated due to the thermal losses produced in the conductor. This temperature rise will cause longitudinal expansion of the conductor. As the rigid installation prevents significant elongation of the cable, compressive stress is developed inside the cable. Similarly, tensile stress occurs during cooling of the cable.

The mechanical stresses lead to forces acting on the cables, joints, terminations, cleats and support structure and this must be considered carefully at system design stage.

2. A Flexible Cable System Design

Flexible cable systems allow the cable to expand thermally in length by deflecting laterally and then allow the cable to return to the original formation on cooling. In order to control the movement of the cable within pre-determined limits, it is usually installed in an approximate sinusoidal formation. Cable cleats are positioned at appropriate intervals so that expansion takes place by an increase in the amplitude in each loop of the sine wave. As the flexible system allows cable expansion to take place it is not characterized by the high values of thrust that occur in the rigidly restrained system. The cable possesses bending stiffness and so the thermo-mechanical axial force is not reduced to zero, but to a small residual magnitude. To ensure that cable expansion does not move from one flexible wave to another it is important to achieve uniform wave geometry by:

- Locating the cable wave fixing points, which are usually cleats, at a constant spacing along the route.
- Setting constant wave amplitude (the offset) in each cable wave.
- If the wave geometry is uniform:
 - The cable is placed in a low compressive force.
 - The forces on the cleat will be of equal and opposite magnitude.
 - There will be no longitudinal cable movement between wave spans.
 - The limited force difference generated by geometrical imbalance between adjacent waves may be restrained by the holding force of a cable cleat, if deemed necessary for the design of the cable system.

The cable cleats on large conductor systems are required to withstand high axial and lateral thermo-mechanical and electro-mechanical loads for the life-time of the cable system under conditions of ambient and operating temperature and under adverse environmental conditions. Failure of the cable cleats to maintain their performance level may result in the impairment of the insulation integrity of the cable, joint or cable termination. To achieve a satisfactory cable system life, it is important that the cable cleats are selected, their performance is tested, and they are installed with care.

It is important to the longevity of the cable that the cable cleat does not damage the cable's polymeric oversheath and/or metallic sheath. The cable oversheath plays a key role by:

- Preventing water ingress to, and corrosion of, the primary water barrier, the metallic sheath.
- Withstanding the induced voltage in the metallic sheath in a specially bonded cable system

The functions of a cleat in a thermo-mechanical cable system are two-fold:

- To hold the cable in alignment along its predetermined route.
- To constrain the following cable forces:
 - Gravitational
 - Lateral short circuit
 - Thermo-mechanical

The exact role of a cable cleat will often differ from site to site. Panduit's team of experts can assist at every stage of the system design.

The Role of a Cable Cleat During a Fire

It is vital that a cable fixing does not compromise circuit integrity in the event of a fire. There are numerous international codes and standards which describe the performance of the cable, but many also highlight that the fixing must at least equal the performance of the fire-resistant cable. The National Fire Protection Association NEC documents include many such demands upon the cable fixings. Panduit's Stainless steel solutions provide the performance required in such applications. Any polymers used in the Panduit range of cable cleats are Low, Smoke, and Fume (LSF), Halogen free and pass the requirements of V0 UL94.

Operating Temperatures

Depending upon the exact cleat material, Panduit's cable cleats are designed for use in ambient temperatures ranging from -50°C to +60°C and with cable conductor temperatures up to 90°C. Although 90°C is often used in the cable conductor specification and calculations it is rarely seen on the outside surface of the cable.

Panduit Cable Cleat Agency Approvals

American Bureau of Shipping

The American Bureau of Shipping (ABS) is a maritime classification society established in 1862. Its stated mission to promote the security of life, property and the natural environment, primarily through the development and verification of standards for the design, construction and operational maintenance of marine and offshore assets. ABS' core business is to provide global classification services to the marine, offshore and gas industries.



DNV GL

DNV GL is the world's largest classification society. It is also the largest technical consultancy and supervisory to the global renewable energy (particularly wind, wave, tidal and solar) and oil & gas industry - 65% of the world's offshore pipelines are designed and installed to DNV GL's technical standards. Prior to the merger, both DNV and GL have independently acquired several companies in different sectors, such as Hélimax Energy (Canada), Garrad Hassan (UK), Windtest (Germany) and KEMA (Netherlands), which now contribute to DNV GL's expertise across several industries. In addition to providing services such as technical assessment, certification, risk management and software development, DNV GL also invests heavily in research.



CE

CE marking is a certification mark that indicates conformity with health, safety, and environmental protection standards for products sold within the European Economic Area (EEA).[1] The CE marking is also found on products sold outside the EEA that are manufactured in, or designed to be sold in, the EEA. This makes the CE marking recognizable worldwide even to people who are not familiar with the European Economic Area. It is in that sense similar to the FCC Declaration of Conformity used on certain electronic devices sold in the United States.



CULUS

All Panduit Cleats are CULUS listed to UL2239.





Since 1955, Panduit's culture of curiosity and passion for problem solving have enabled more meaningful connections between companies' business goals and their marketplace success. Panduit creates leading-edge physical, electrical, and network infrastructure solutions for enterprise-wide environments, from the data center to the telecom room, from the desktop to the plant floor. Headquartered in Tinley Park, IL, USA and operating in 112 global locations, Panduit's proven reputation for quality and technology leadership, coupled with a robust partner ecosystem, help support, sustain, and empower business growth in a connected world.

For more information

Visit us at www.panduit.com/cablecleat

**Contact Panduit North America Customer Service by email: cs@panduit.com
or by phone: 800.777.3300**

THE INFORMATION CONTAINED IN THIS ARTICLE IS INTENDED AS A GUIDE FOR USE BY PERSONS HAVING TECHNICAL SKILL AT THEIR OWN DISCRETION AND RISK. BEFORE USING ANY PANDUIT PRODUCT, THE BUYER MUST DETERMINE THE SUITABILITY OF THE PRODUCT FOR HIS/HER INTENDED USE AND BUYER ASSUMES ALL RISK AND LIABILITY WHATSOEVER IN CONNECTION THEREWITH. PANDUIT DISCLAIMS ANY LIABILITY ARISING FROM ANY INFORMATION CONTAINED HEREIN OR FOR ABSENCE OF THE SAME.

All Panduit products are subject to the terms, conditions, and limitations of its then current Limited Product Warranty, which can be found at www.panduit.com/warranty.

* All trademarks, service marks, trade names, product names, and logos appearing in this document are the property of their respective owners.

PANDUIT US/CANADA
Phone: 800.777.3300

PANDUIT EUROPE LTD.
London, UK
cs-emea@panduit.com
Phone: 44.20.8601.7200

PANDUIT SINGAPORE PTE. LTD.
Republic of Singapore
cs-ap@panduit.com
Phone: 65.6305.7575

PANDUIT JAPAN
Tokyo, Japan
cs-japan@panduit.com
Phone: 81.3.6863.6000

PANDUIT LATIN AMERICA
Guadalajara, Mexico
cs-la@panduit.com
Phone: 52.33.3777.6000

PANDUIT AUSTRALIA PTY. LTD.
Victoria, Australia
cs-aus@panduit.com
Phone: 61.3.9794.9020