

THIS COPY IS PROVIDED ON A RESTRICTED BASIS AND IS NOT TO BE USED IN ANY WAY DETRIMENTAL TO THE INTERESTS OF PANDUIT CORP.

Material	High Conductivity Seamless Copper Tube
Plating	Electro-Tin
Wire Size	250 STR/FLEX
Wire Type	Stranded Copper: Compact, Class G, H, I, K, M, Locomotive
Wire Strip Length	2-5/16 in.
Stud Size	1/2 in.
UL Listed Wire Connector	Yes, for applications up to 35kv. Consult cable manufacturer for voltage stress relief instructions with applications greater than 2000 volts.
UL Temperature Rating	90° C
C.S.A Certified Wire Connector	Yes
Panduit Color Code on Barrel	YELLOW
Panduit Die Index No. on Barrel	P62
Alternate Industry Die Index No. ( ) on Barrel	(16)

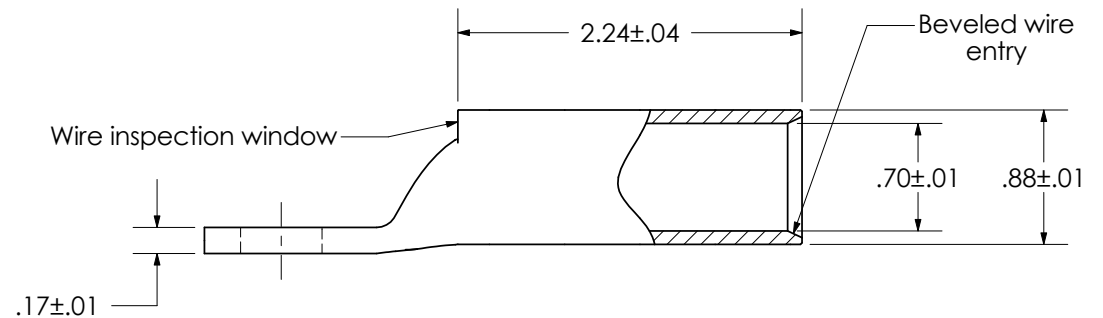
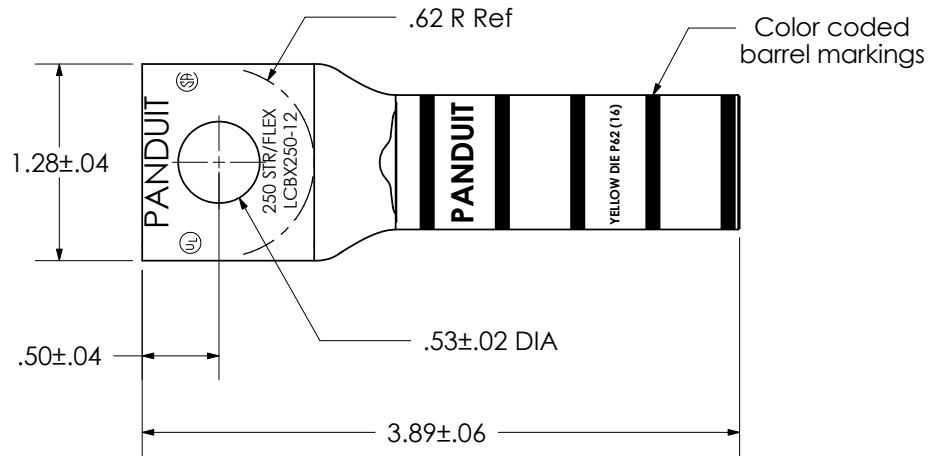

00	1/09	JHNU	JHNU	RELEASED	
REV	DATE	BY	CHK	DESCRIPTION	ECN

**PANDUIT CORP. TINLEY PARK, ILLINOIS**

LCBX250-12-X  
Copper Lug - One-Hole, Long Flex Barrel

SCALE N/A DRAWING NO / CAD FILE LCBX250-12-CUST