

G6 Intelligent PDUs

Best-in-Class Outlet Density

Optimal Form Factors

Superior Reliability



iPDU Value Proposition



Quality & Reliability
3-Year standard and 6-Year extended warranty

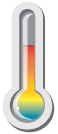

High Temp
Built with premium components to withstand 140°F (60°C) at full load

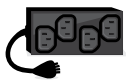

High Power Density
Unique outlets design for high outlet density



Hot-Swappable and Upgradable
Hot-Swappable Controller with large OLED display



Hardened Security
Enhanced security with certificate-based advanced asymmetric encryption, validated and hardened with multiple security scanning tools



1G Redundant Network Access
Reduces deployment time and labor as PDU auto negotiates to 1GB network switches



Real-Time Monitor
Real-time Monitoring of Power Environmental and Cabinet Security

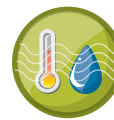

Environmental Plug & Play Accessories
Variety of Environmental and Cabinet Access Control Accessories



Multi-Device WebGUI
Enhanced User-Experience with a self adjusting WebGUI that senses the device you are on



Multi-Color
A variety of colored PDU chassis, power cords and cable ties

iPDU Families

Monitored Input (MI) Series

Input power monitoring.

Monitored Switched (MS) Series

Input power monitoring and outlet switching.

Monitored per Outlet (MPO) Series

Input and Outlet level power monitoring.

Monitored and Switched per Outlet (MSP0) Series

Input and Outlet level power monitoring and outlet switching.

Accessories

A variety of Environmental Sensors; Security Devices; and Power Cords.

Note: All intelligent PDUs Include capabilities for environmental monitoring and rack access control.

iPDU Key Features

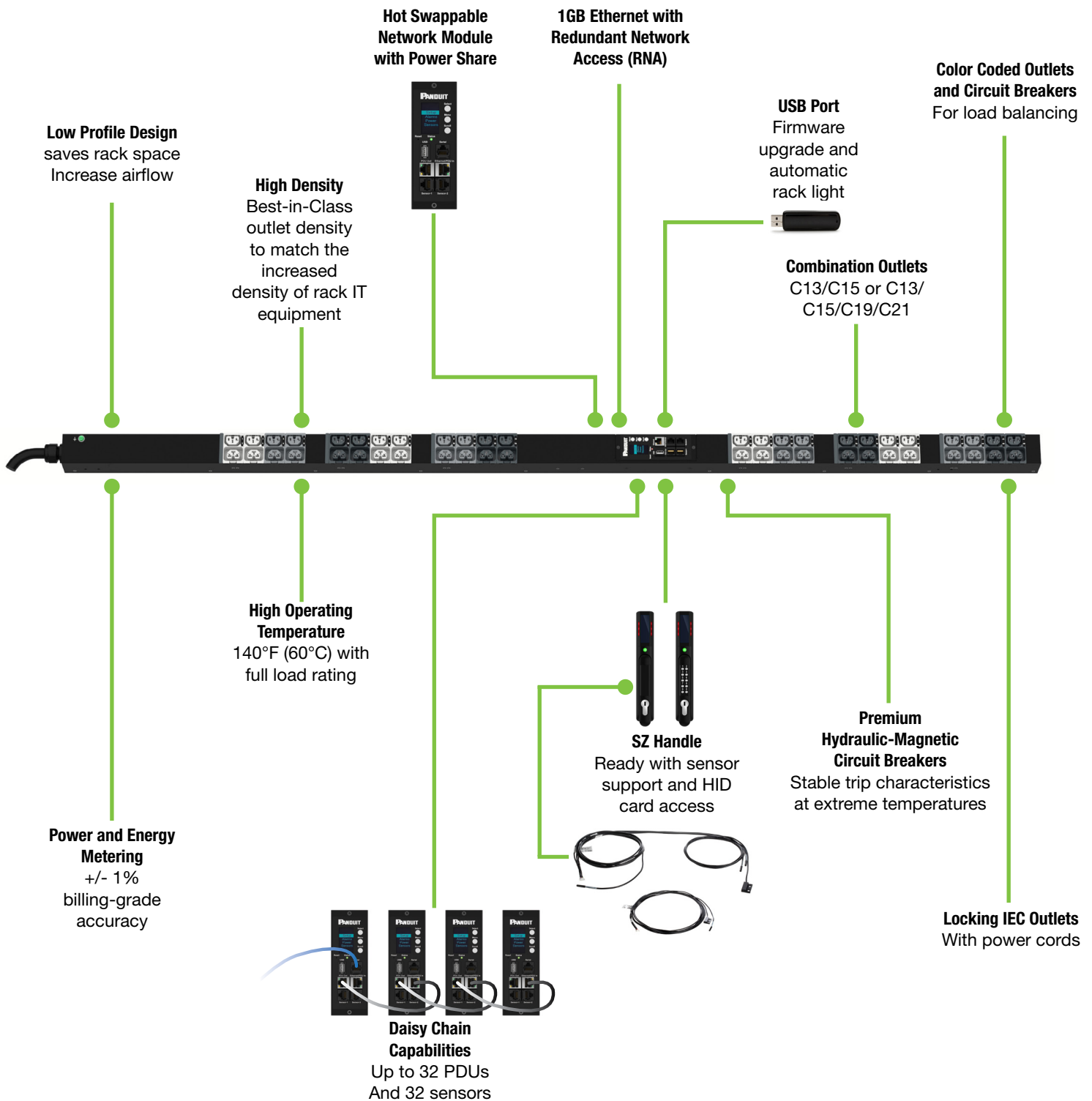

Product Features	Monitored Input (MI)	Monitored Switched (MS)	Monitored per Outlet (MPO)	Monitored & Switched per Outlet (MSPO)
Design Features <ul style="list-style-type: none"> • Low profile, space saving design • Ultra low profile circuit breakers on most models • Adjustable tool-less mounting system • Color coded receptacles • Locking IEC receptacles and locking power cord compatible • Symmetric vertical PDU Chassis to accommodate top or bottom power feed 	•	•	•	•
PDU Energy Metering and Monitoring <ul style="list-style-type: none"> • PDU level watt-hour energy metering (kWh) • PDU level power measurements (W) • Input Phase level power measurements (V, A, VA, kWh, pf) • Circuit breaker level current measurements* • High-accuracy, billing-grade metering capabilities • Embedded memory log to record/view/report historical data • User customizable alarm thresholds & notifications 	•	•	•	•
Environmental Management <ul style="list-style-type: none"> • Optional Plug & Play environmental sensors including temperature, humidity, dry contact and water leak • User customizable alarm thresholds and notifications 	•	•	•	•
SmartZone™ Security Handle <ul style="list-style-type: none"> • Beacon LED to locate cabinets and provide automated visual indication for critical and warning alarms • Status LED provides visual indication of the handle and security status • Up to 200 Users for cabinet access • Multi-Frequency HID 125KHz/13.5MHz, Mifare & iClass • Dual Authentication (Keypad Version) • Field Replaceable Tumblers and Key (5 Options) 	•	•	•	•
Network Management and Local Display Interface <ul style="list-style-type: none"> • Largest-in-class, high-visibility, OLED display • Full featured network management and alerting capabilities supporting HTTP, HTTPS, SSH, Telnet, SNMP, FTP and email • Strong encryption, passwords, and advanced authorization options including local permissions, LDAP, RADIUS, and Active Directory • Daisy Chain up to 32 Rack PDUs and 32 environmental sensors through a single IP address 	•	•	•	•
Circuit Breaker Status Monitoring <ul style="list-style-type: none"> • Active monitoring and alarming of circuit breaker on/off status 	•	•	•	•
Outlet Level Switching <ul style="list-style-type: none"> • Remote On/Off power control by individual outlet • User-defined power-on time delay to sequence IT equipment • Automatic sequencing to avoid inrush current overload • Outlet level user security with assignable roles and user access 		•		•
Outlet Level Energy Metering <ul style="list-style-type: none"> • Outlet level watt-hour energy metering (kWh) • Outlet level power measurements (V, A, VA, W, pf) • Outlet level information for Green Grid Level 3 PUE Calculations 			•	•

Locking Outlets and Cables

- Locking outlets compatible to dual locking power cords
- Dual locking power cords provide locking at both end (PDU and equipment)
- Variety of power cords lengths and colors available
- Integrated cable tie slot for non-locking power cord retention

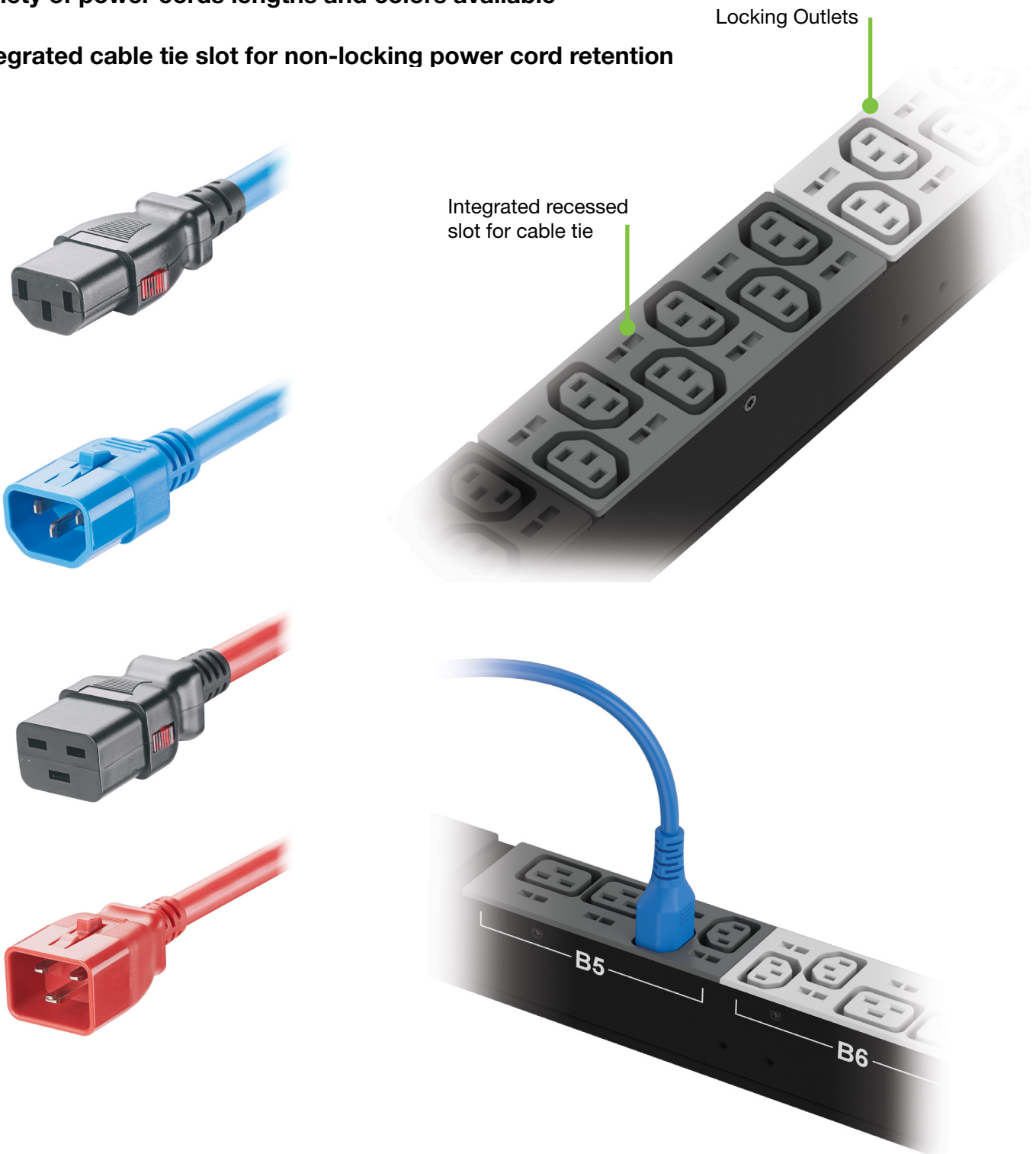

G6 Intelligent Network Controller (iNC) (Hot Swappable)



iPDU

Web GUI



Login

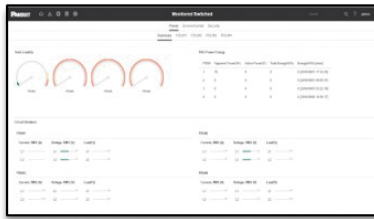

Dashboard

Multi-Device Access

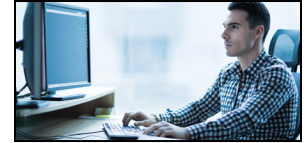

Desktop



Tablet

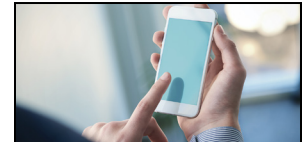

Smartphone

iPDU

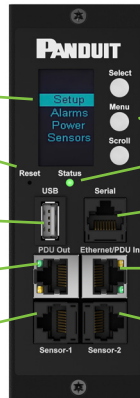

High Visibility OLED

Reset/Factory Default

USB for firmware/configuration updates, and/or optional automatic rack light

PDU Out for Daisy Chain

Sensor Port

Menu Selector Buttons

Status LED

Serial Connection Port compatible with MA017 Yost Data Cable.

PDU In for Daisy Chain or Serial Connection

Sensor Port

Intelligent

Security Handle

Features

- Up to 200 users
- Multifrequency card access
- HID 125KHz/13.5MHz, Mifare and iClass
- Dual authentication (keypad version)



ACF05



ACF06

Card Reader

Card Reader

Beacon LEDs

Status LED

Integrated Humidity Sensor

Keypad (ACF06)

Specially designed accessories to connect directly to the security handle. The security handle features an integrated humidity sensor.

Environmental and Security

- Temperature + Door Contact (ACF10)



- (3) Temperature + Door Contact (ACF11)



- Harness to connect security handle to Panduit G6 iPDU (ACF20)

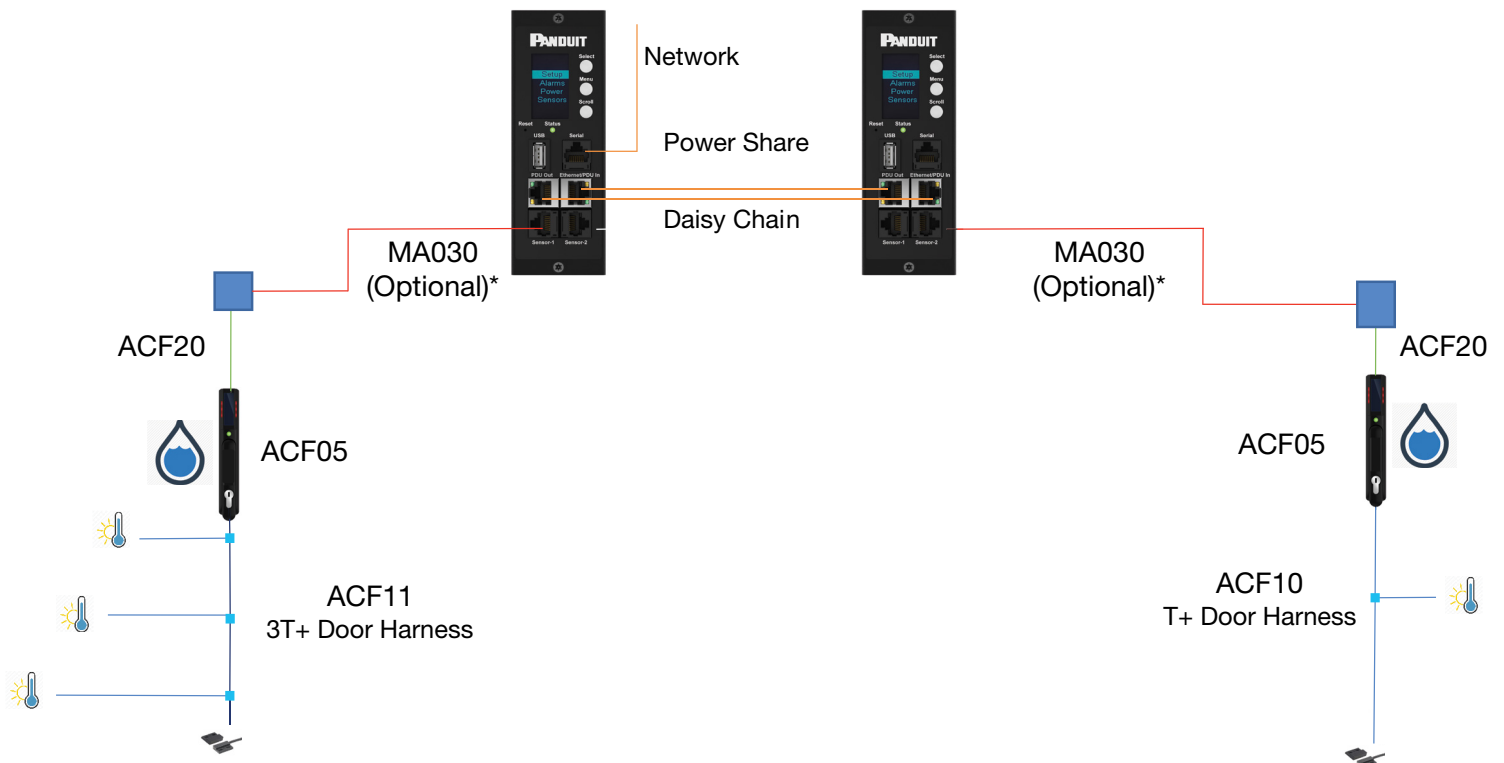

*The MA030 features a coupler to optimize door removal and is 10 ft. (3m) in length.

Accessories — Environmental, Security and Power Cords

Security and Environmental Accessories that connect directly to the G6 iPDU, when NOT using security handle

Environmental

- Temperature (EA001)
- Temp + Humidity (EB001)
- 3Temp + Humidity (EC001)



- Rope Leak (ED001)
- Spot Leak (EE001)



- 3 Sensor Input Hub (EF001)



- Dry Contact Input (ACC01)



Security

- Door Contact Switch (ACA01)



- Auto Light Bar (ACD01)



Power Cords

- Dual Locking Power Cords

